



P360
WALL SOLUTIONS



CHAPTER 1:
THE JOURNEY BEGINS

Experience the future of learning, vertically reimaged.



It all comes together...



Decades of research and collaboration with educators revealed a critical need: to maximize learning potential by transforming underutilized wall space.

We discovered that classrooms were often:

- Cluttered, limiting movement and creativity
- Lacking unified, integrated solutions
- In need of versatile, technology-ready spaces

Armed with these insights, we assembled a team of visionaries:

- Experienced educators
- Innovative designers
- Technology integration experts

The result? A revolutionary approach to classroom design that optimizes every square inch for learning.

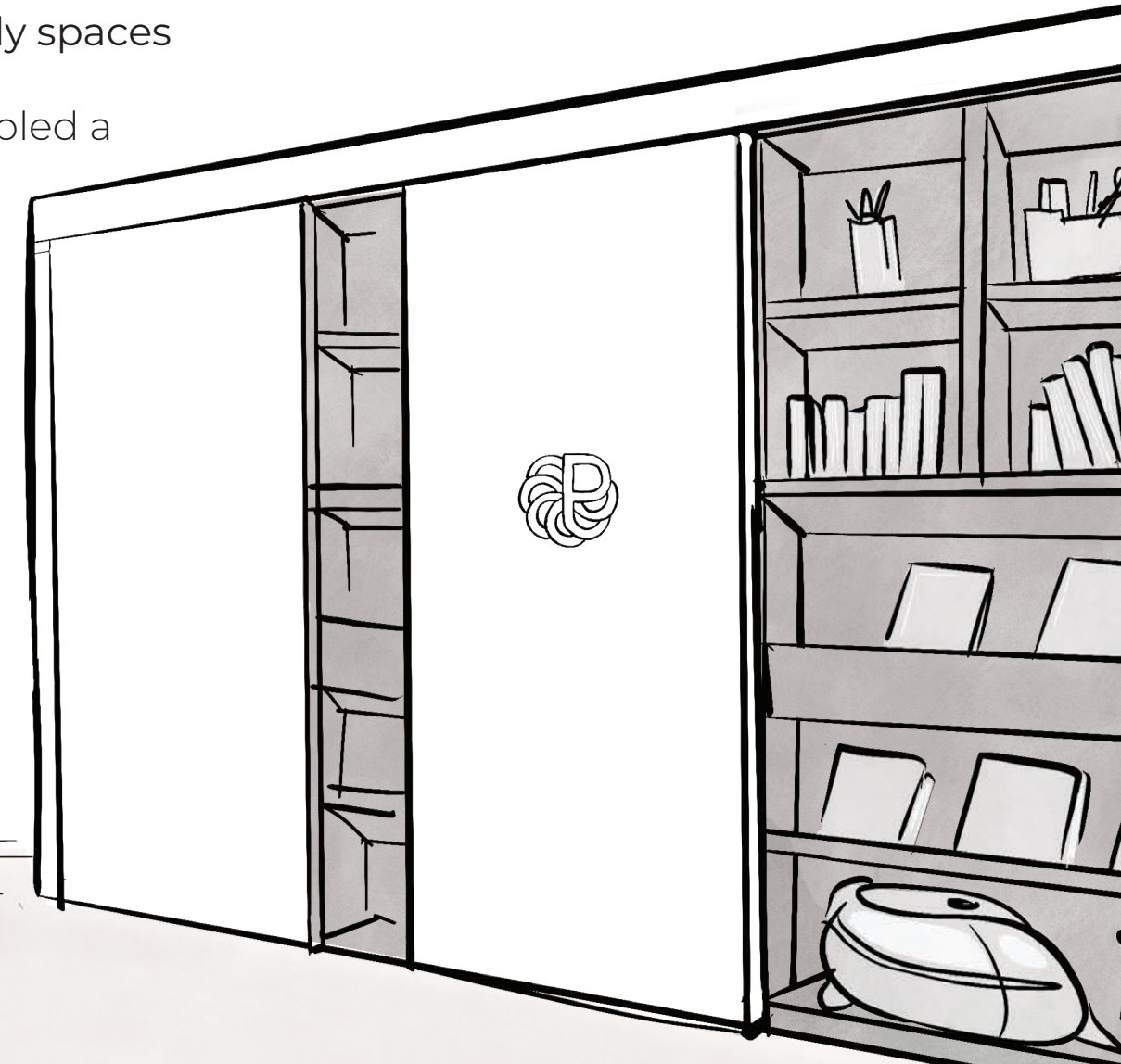

CHAPTER 2: BUILDING A VILLAGE



OUR JOURNEY: 60 YEARS OF EVOLUTION

From Whiteboards to P360.

1960s

For 6 decades, we specialized in whiteboards and tackboards, transforming standard classrooms one wall at a time.

15 Years Ago

As classrooms became more active, the floor space filled, and walls were left underutilized.

2020

THE PROBLEM EMERGES

5 Years Ago, increased collaboration and new research on acoustics and visual acuity raised a critical question:

How do we solve this?

The Big Question...

How can walls be reimagined to store, organize, absorb sound, and engage the senses?

2023

CRAFTING SOLUTIONS

By listening to educators, architects, and researchers, we began designing solutions to make walls work harder and smarter.

★ STAKEHOLDERS



Superintendent



Facility Manager



Construction



Purchasing



Educator



Learner

2025

THE RESULT:

A fully activated wall system that revolutionizes learning spaces through intuitive design



P360 system provides several key advantages:

- Maximizing wall space
- Providing writable surfaces
- Improving visual acuity
- Reducing floor clutter
- Integrating technology
- Enhancing acoustics
- Offering adaptable configurations

• STATISTICS



Superintendents:
16% improved learning progress



Facilities Managers:
30% reduced maintenance costs

96%

Educators:
96% enhanced teaching effectiveness



Students:
81% improved academic performance



P360

IT TAKES A VILLAGE

Connecting with the best partners, together, we set out to create an intuitive, integrated system that would:

- Activate vertical surfaces as dynamic learning tools and sensory spaces
- Declutter floor space, enhancing mobility and flexibility
- Seamlessly blend technology, organization, and collaboration

"Alone, we can do so little; together, we can do so much."

- Helen Keller



Before P360



After P360



Our solutions began to come to life,



From the spaces in which we learn.

The spaces in which we 'make'

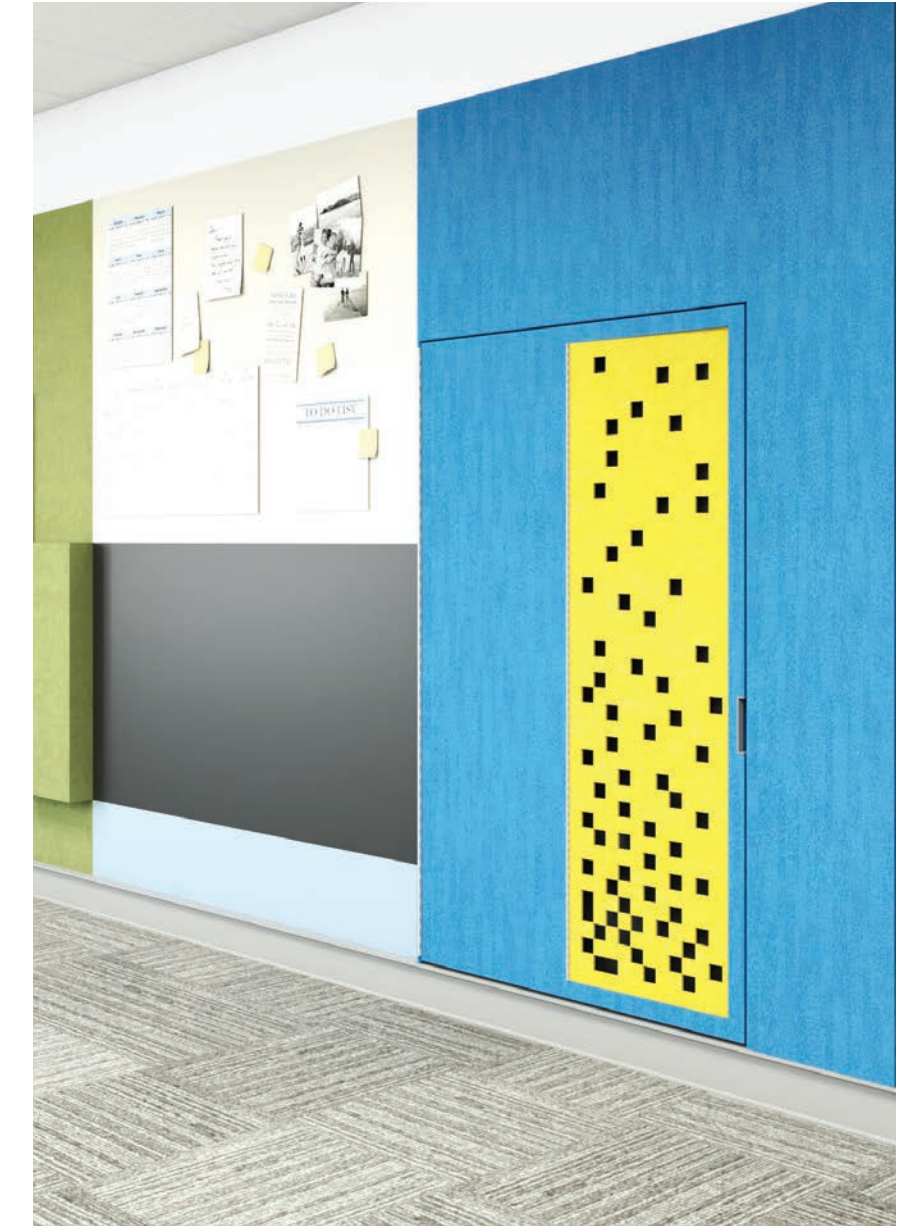

and spaces to escape.

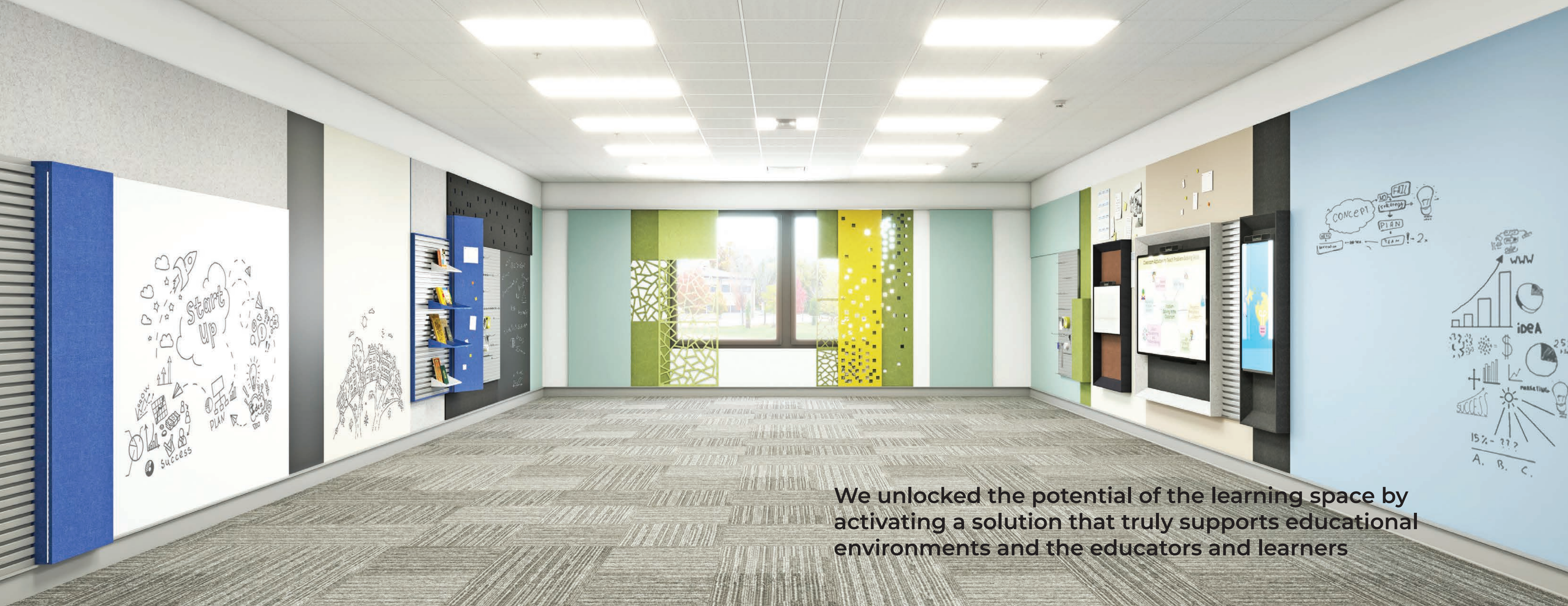

We unlocked the potential of the learning space by activating a solution that truly supports educational environments and the educators and learners



CHAPTER 3: TRANSFORM. ACTIVATE. CREATE

P360: A SYSTEMS BASED SOLUTION TO ENGAGING THE ACTIVE WALL

Our customizable kit of parts empowers educators to craft a unique canvas for learning, utilizing walls as key elements in the educational process. This modular system offers:

1. Versatile writable surfaces for collaborative brainstorming
2. Interactive display areas for showcasing student work
3. Flexible storage solutions that adapt to changing needs
4. Technology integration points for digital learning experiences
5. Modular components that can be reconfigured as needed



How to create your wall

A step by step guide to activating the wall

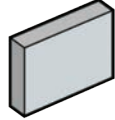

1. Choose your wall.



2. Choose your color palette.



3. Confirm your dimensions and other specifications.



4. Activate your wall.





SOLUTIONS



Whether you choose a curated kit or a create your own custom design, our research-driven approach ensures your space will inspire limitless possibilities for learning and engagement.

Our versatile systems adapt to any learning environment, empowering you to activate your walls your way.

- **Pre-curated wall kits:** Ready-to-implement solutions based on extensive research
- **Custom designs:** Tailor every component to your unique space and needs

Custom Solutions Tailored for Every Learning Need.

The innovative P360 system revolutionizes this space by transforming every wall into a multifunctional asset for teaching and learning.

This comprehensive solution addresses key challenges faced by educators and students alike, offering a range of benefits that enhance the overall classroom experience

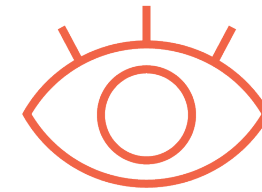

Visual Acuity

Every student sees clearly, no matter where they sit.



Acoustics

Sound-optimized spaces for better learning experiences.



Contrast & Clarity

Engaging colors and typography that avoid visual overload.

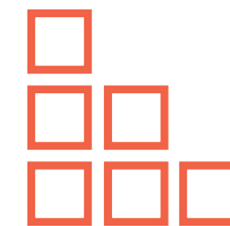

Minimal Clutter

Clean, interactive walls that reduce distractions.

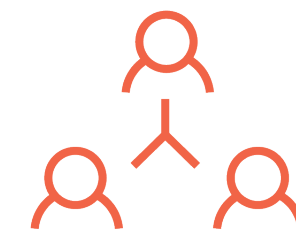

Safety & Engagement

Open environments that encourage collaboration and creativity.



EdTech Wall

The EdTech Wall is designed to power and empower any space, with a focus on accessibility this wall provides all learners the opportunity to engage seamlessly with digital tools.



IDEAtion Wall

Foster Collaboration through Ideation and visual learning. Our ideation walls create the space where learners seamlessly work together, sharing ideas on writable surfaces that inspire teamwork.

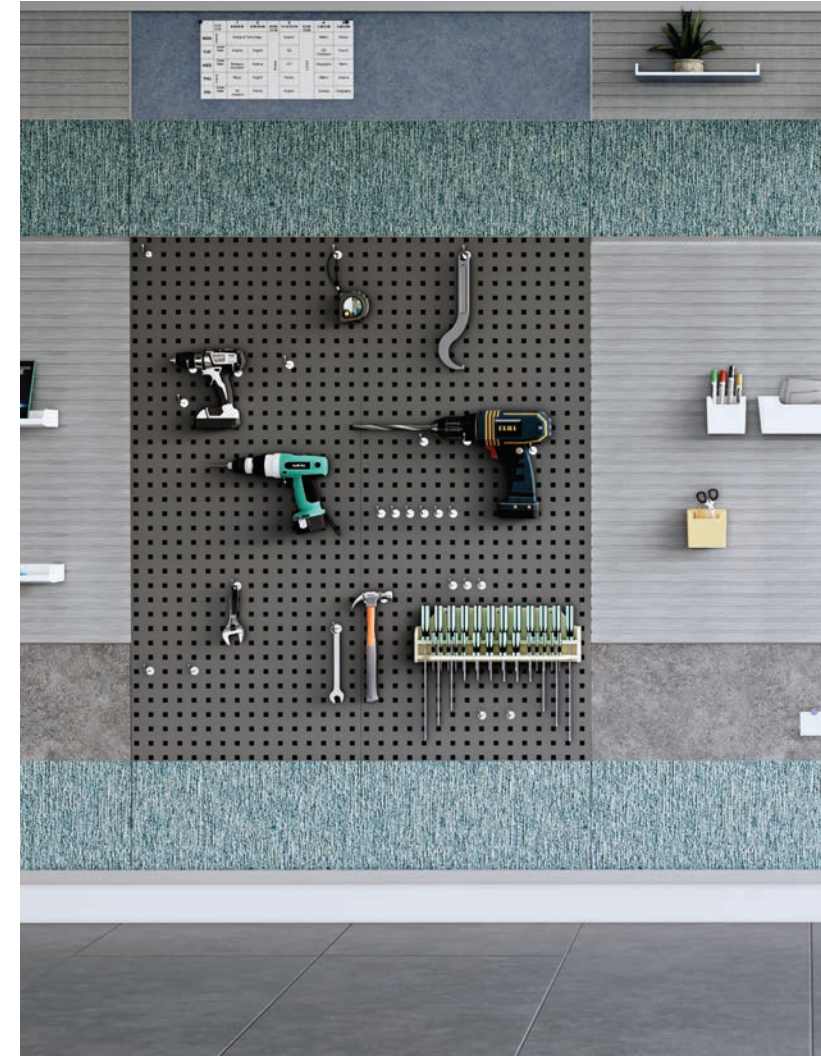

Jobs Wall

Perhaps the hardest working space in any learning environment, the customizable Jobs Wall enhances organization, provides easy access to materials, and unlocks additional storage solutions creating more space on the floor.



Window Wall

This solution adds a remarkable dimension to your space. By using our mounting systems, you can transform windows into additional learning surfaces, unlocking new potential.

EDTECH WALL

The EdTech Wall, featuring the Ryze-Up Mounting System, seamlessly integrates technology into classroom design, optimizing space, visibility, and instructional efficiency.

- Moves displays off the floor, creating a clear focal point while maximizing storage.
- Reduces low-frequency hums with “Hoodie” technology for a more inclusive learning environment.
- Durable, institutional-grade construction designed to support evolving classroom technology needs.



Visual Acuity
Acoustics
Contrast & Clarity
Reducing wall clutter
Safety & Engagement

PARTS OF SPEECH

NOUN	VERB	ADVERB
Girl	Talk	Slowly
Teacher	Sleep	Happily
Park	Throw	Calmly
Airport	Sing	Quickly
House	am	Today

EDTECH WALL

SPEC GUIDE

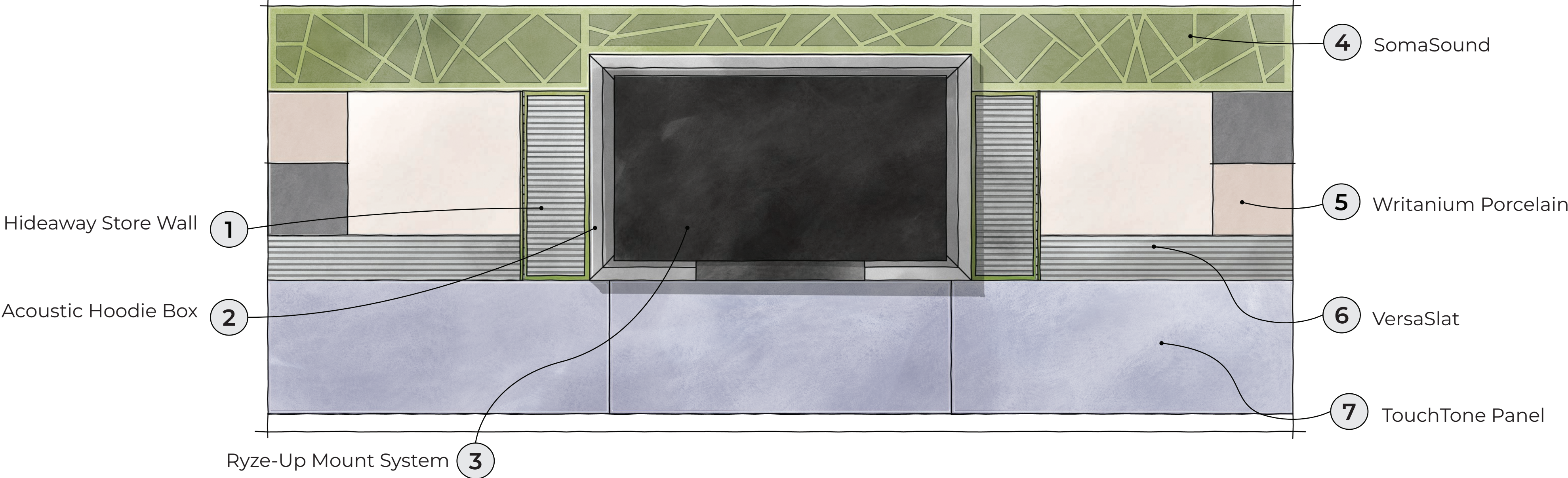

RYZE-UP MOUNTING SYSTEM

This Innovative manual height adjustable mount allows you to smoothly move your interactive display up and down with just a touch, enhancing ergonomic comfort in any setting.

FEATURES:

- **Ergonomics:** Effortless high-low adjustment
- **Compact design:** Hidden behind the screen, black textured finish
- **Safety:** UL listed and CE (ISO 60950)
- **Manual:** No motor, no electricity needed
- **Reliability:** Tested to 60.000 cycles
- **Mounting:** Easy and safe mounting, different surfaces < 30 minutes
- **Logistics:** Compact packaging, relatively low transport costs

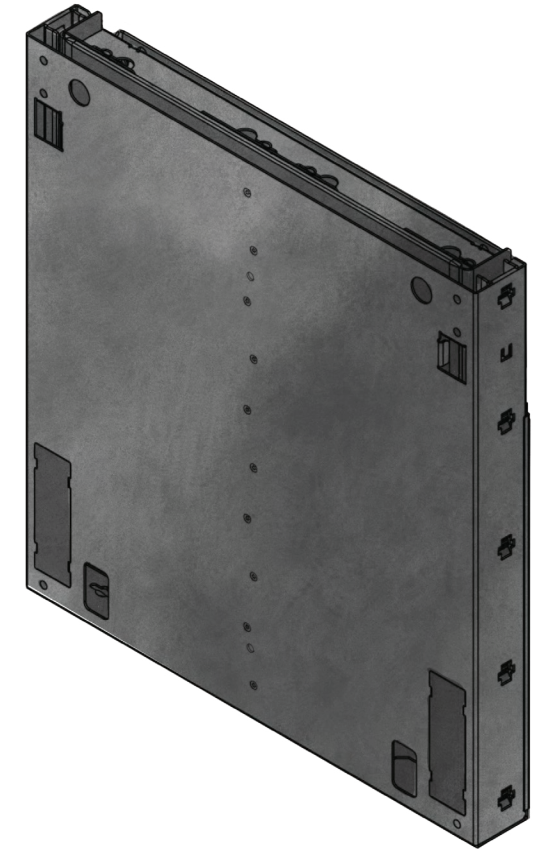
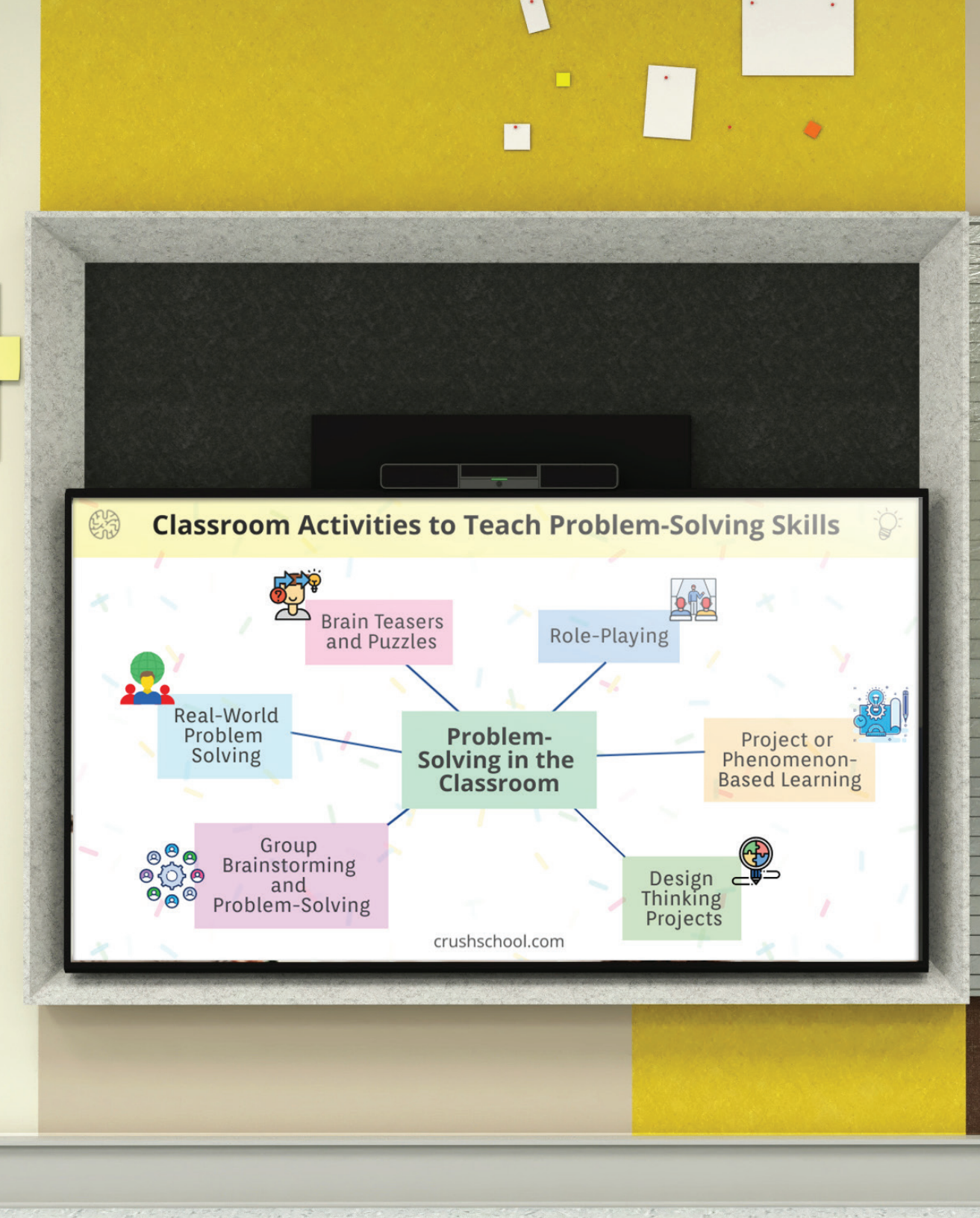

ACOUSTIC HOODIE BOX

The Acoustic Hoodie offers enhanced sound absorption through its unique acoustic cavity, creating a functional and aesthetic solution. This innovative design provides a way to dampen echoes and reduce background noise, making it a practical addition to spaces needing subtle acoustic treatment.

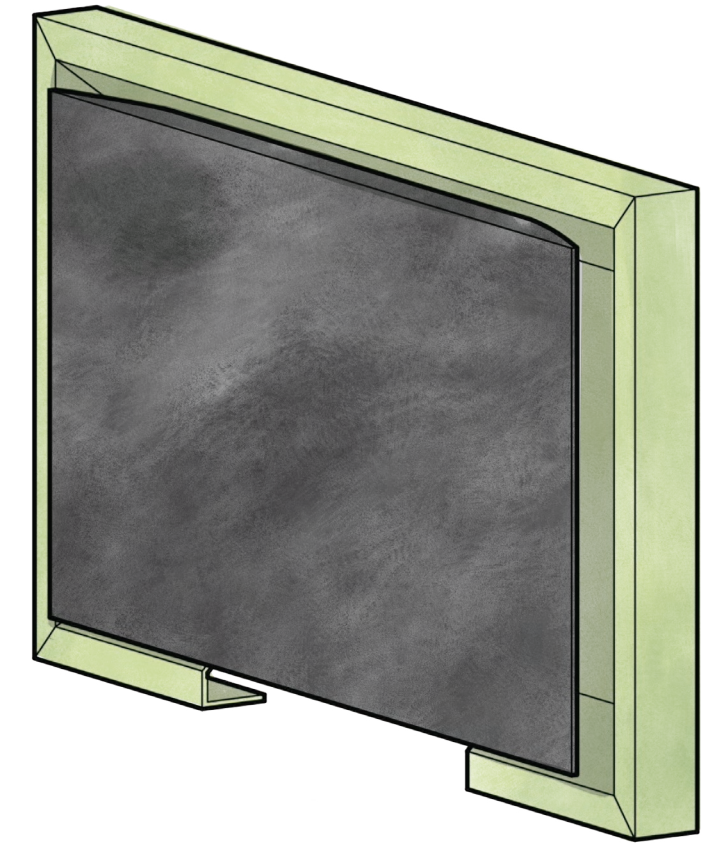

IDEAtion WALL

The Ideation Wall is a teacher's essential tool for organization, wellness, and creativity, fostering a focused and engaging classroom environment.

- Tackable, noise-reducing panels improve acoustics while reducing wall clutter.
- Supports scheduling, student engagement, and a positive learning atmosphere through color science.
- Durable, low-maintenance design with built-in backpack storage and easy wall mounting.



IDEAtion WALL

SPEC GUIDE

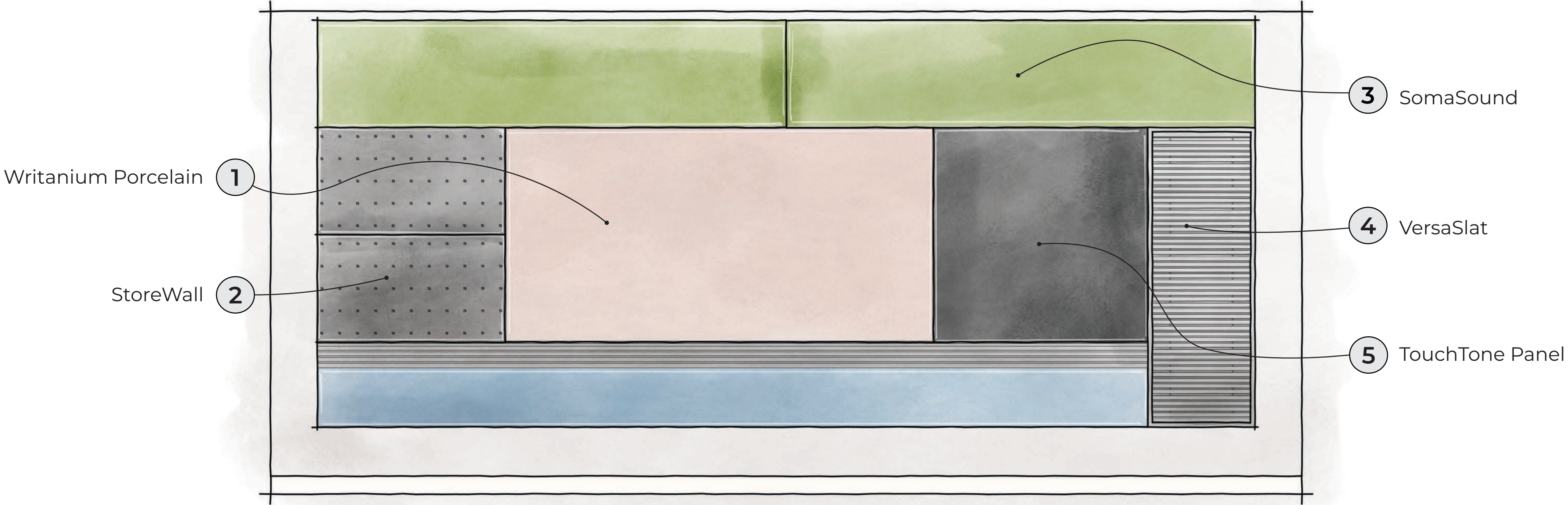

JOBS WALL

This versatile storage solution is designed for classrooms and specialized spaces, offering customizable materials, adaptable configurations, and durable, low-maintenance construction.

- Supports CTE, Makerspace, and rolling cart storage to maximize flexibility.
- Eliminates or reduces the need for costly fixed casework.
- Built with commercial-grade, heavy-duty materials for long-term institutional use.



JOBS WALL

SPEC GUIDE

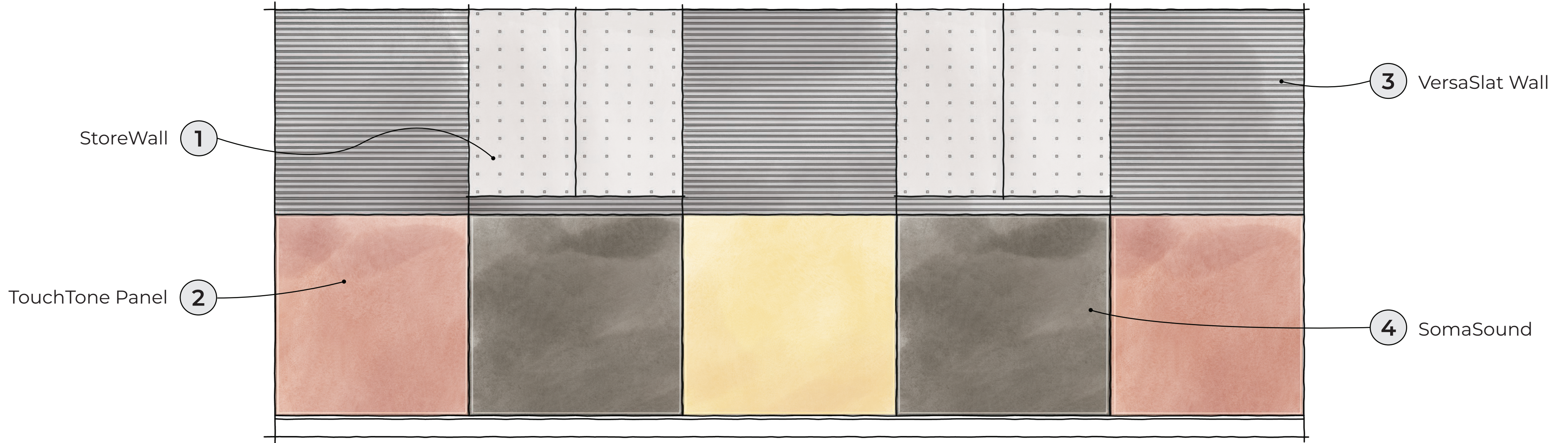

WINDOW WALL

The Track Star Window Wall transforms a passive vertical surface into a multifunctional learning wall, enhancing energy efficiency, safety, and classroom comfort.

- Reduces HVAC costs, eliminates corded blinds, and provides real-time security control.
- Complies with fire access guidelines while integrating tackable, sound-reducing materials.
- Durable, low-maintenance design with easy installation for retrofits, modernizations, or new builds.



	1	2	3	4	5
8:00-9:00	8:30-9:30	9:30-10:30	10:30-11:15	11:15-12:15	12:15-12:35
MON	Design & Technology		English	Math	History
TUE	Science	English	Art	PE (Outdoors)	French
WED	Religious Education	Science	Break	ICT	Geography
THU	Music	English	History	Math	Spanish
FRI	PE (Indoors)	French	English	Science	Geography

2025 CALENDAR											
JANUARY			FEBRUARY			MARCH			APRIL		
Mo	1	15	29	Mo	1	15	29	Mo	1	15	29
Tu	2	16	30	Tu	2	16	30	Tu	2	16	30
We	3	17	31	We	3	17	31	We	3	17	31
Th	4	18		Th	4	18		Th	4	18	
Fr	5	19		Fr	5	19		Fr	5	19	
Sa	6	20		Sa	6	20		Sa	6	20	
Su	7	21		Su	7	21		Su	7	21	
Mo	8	22		Mo	8	22		Mo	8	22	
Tu	9	23		Tu	9	23		Tu	9	23	
We	10	24		We	10	24		We	10	24	
Th	11	25		Th	11	25		Th	11	25	
Fr	12	26		Fr	12	26		Fr	12	26	
Sa	13	27		Sa	13	27		Sa	13	27	
Su	14	28		Su	14	28		Su	14	28	
Mo	15	29		Mo	15	29		Mo	15	29	
Tu	16	30		Tu	16	30		Tu	16	30	
We	17	31		We	17	31		We	17	31	
Th	18			Th	18			Th	18		
Fr	19			Fr	19			Fr	19		
Sa	20			Sa	20			Sa	20		
Su	21			Su	21			Su	21		
Mo	22			Mo	22			Mo	22		
Tu	23			Tu	23			Tu	23		
We	24			We	24			We	24		
Th	25			Th	25			Th	25		
Fr	26			Fr	26			Fr	26		
Sa	27			Sa	27			Sa	27		
Su	28			Su	28			Su	28		
Mo	29			Mo	29			Mo	29		
Tu	30			Tu	30			Tu	30		
We	31			We	31			We	31		

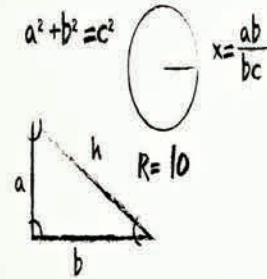

WINDOW WALL

SPEC GUIDE

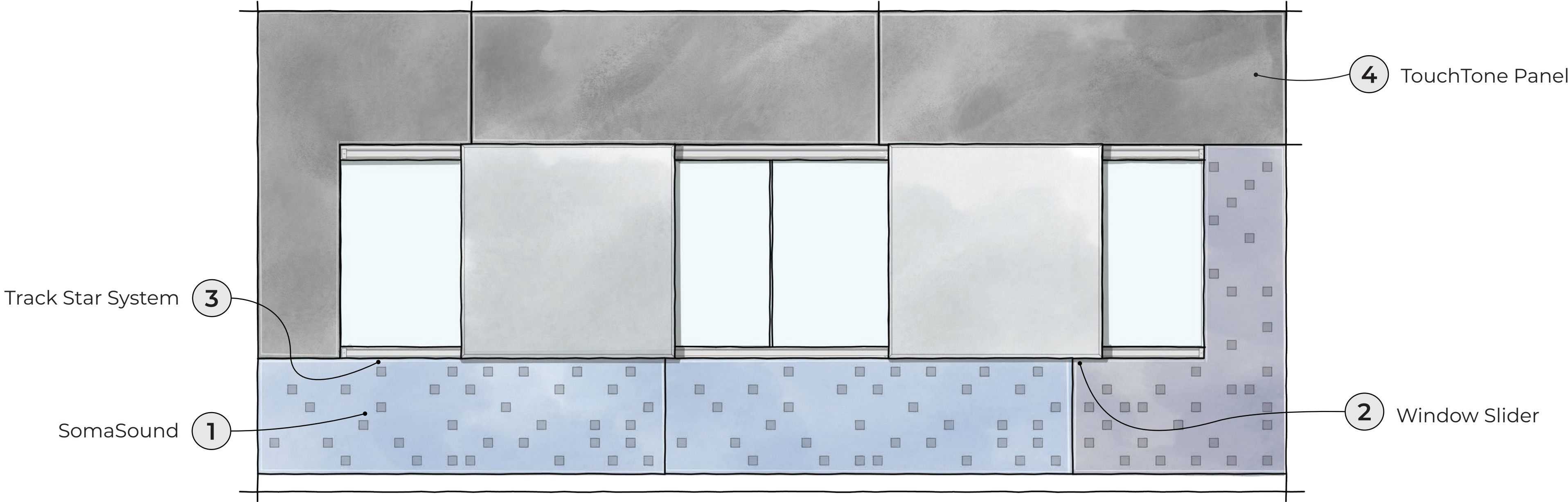



COMPONENTS

SomaSound PANEL

This high-performance material offers superior sound absorption properties, effectively reducing echo and reverberation to create a clearer, more focused auditory experience.

- Textured surface, enhances acoustic performance
- Adds tactile, visually interesting element to the classroom walls
- Color options have been thoughtfully curated to compliment various design schemes
- Promotes calm, conducive learning atmosphere.

- Each set contains 8 Panels, covering a total area of 2.9m² (31 square feet).
- Panels are supplied flat-packed and are easy to install, either wall-to-wall or as standalone feature pieces.



Grass

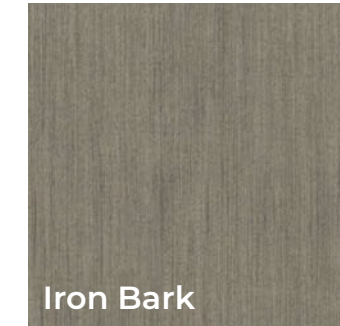

Iron Bark



Mandarin



Spotted Gum

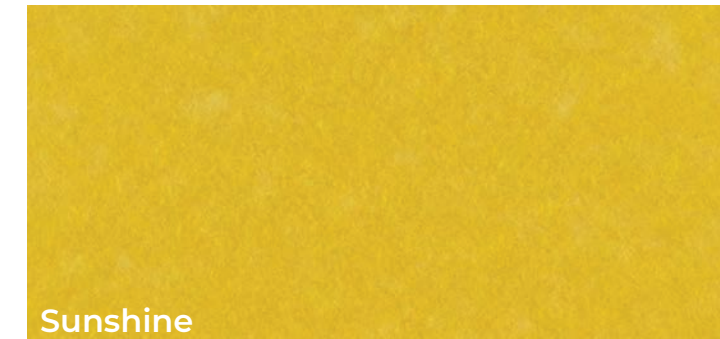

Sunshine



Sky



Slate



Cobalt

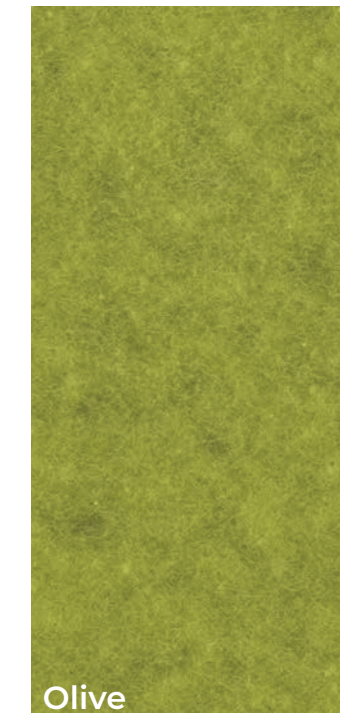

Olive



Saffron



Smoke



Brick

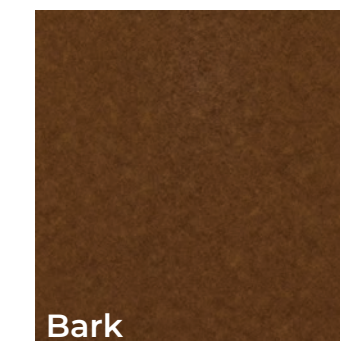

Bark



Pewter

SOMASOUND

Outstanding acoustics
and environmentally
friendly components.

TouchTone PANEL

The **TouchTone** material, offers a unique combination of sensory appeal and practical functionality. Its soft-to-touch surface provides a tactile experience that engages students' senses, creating a more inviting and interactive learning environment.

- Gentle feel with remarkable durability -- designed to withstand the daily rigors of an active classroom.
- With self-healing properties, it serves as an excellent tackable surface.
- Add acoustic values, contributing to a balanced sound environment

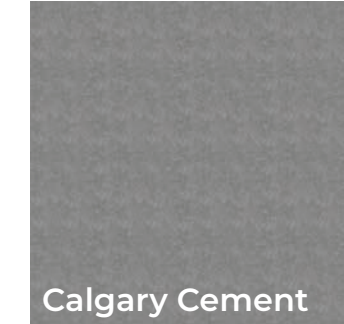

TOUCHTONE

Notable for its tackability, sensory feel, and variety in patterns/colors, enhances room acoustics when used with flooring.

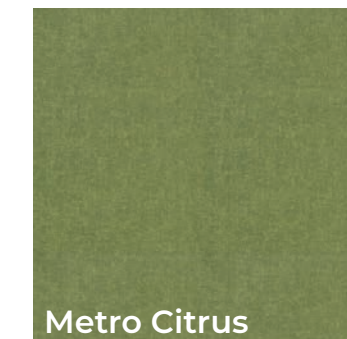
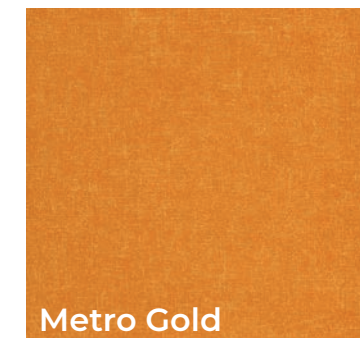

Writanium Porcelain Panel

The Writanium Porcelain surface offering a superior writing experience that transforms classroom interactions. This exceptional porcelain-on-steel surface provides brilliant image clarity with optimum glare control, ensuring clean, crisp writing and effortless erasure.

- Non-porous surface delivers remarkable durability, resisting scratches, and maintaining a pristine appearance.
- Available in a carefully curated range of colors.
- Supports visual acuity while creating a calming aesthetic that enhances the learning environment.

Butt jointed for a continuous writing surface across the seams without streaking.

WRITANIUM™

Guaranteed for the life of the building, it's durable, prevents ghosting, and boasts a proven 70-year track record.

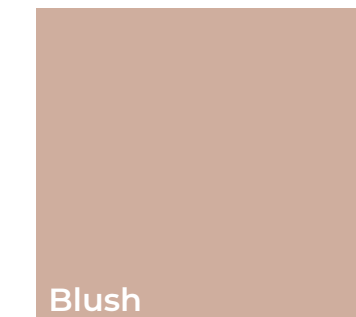
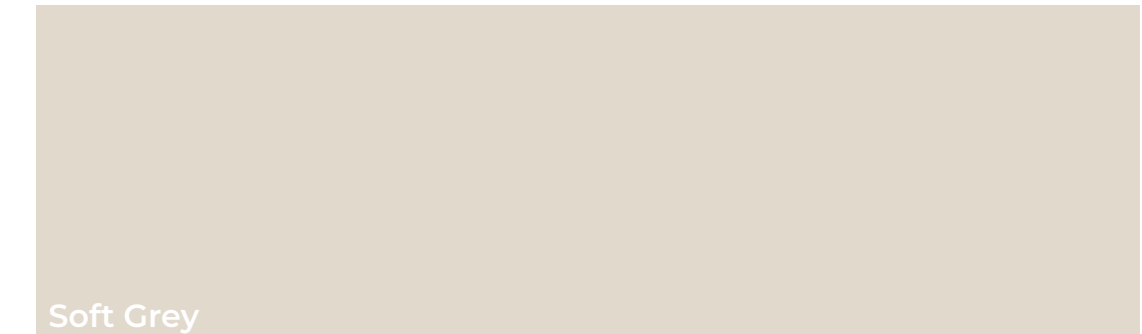
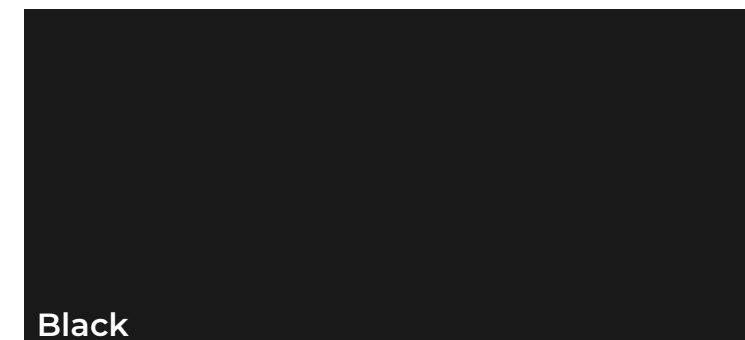
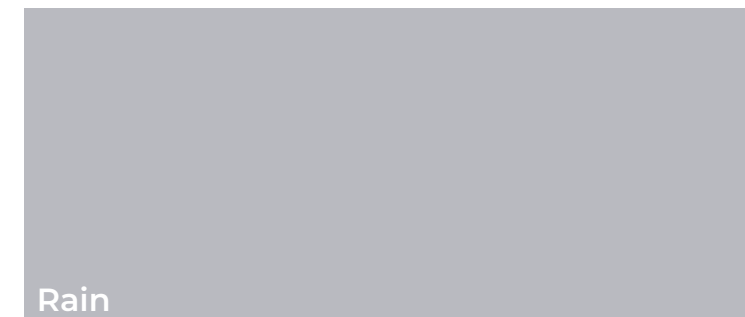
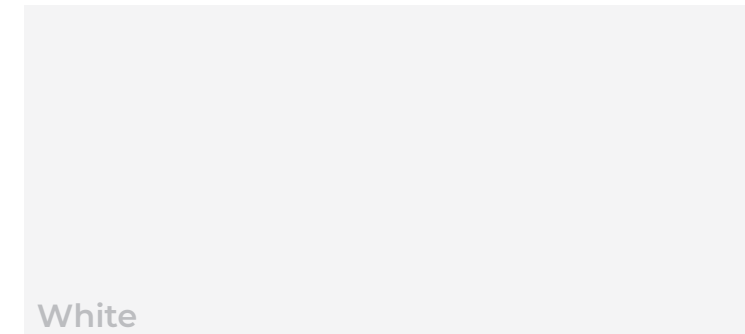

ALL WALL ACCESORIES AND EXTRA'S

Customize further and add our storage organization kit, including:

- > Markerboard Pen Holder
- > Ledge
- > File Storage Container
- > Handy Container
- > Velcro Dots
- > Tablet Holder
- > Tape Holder

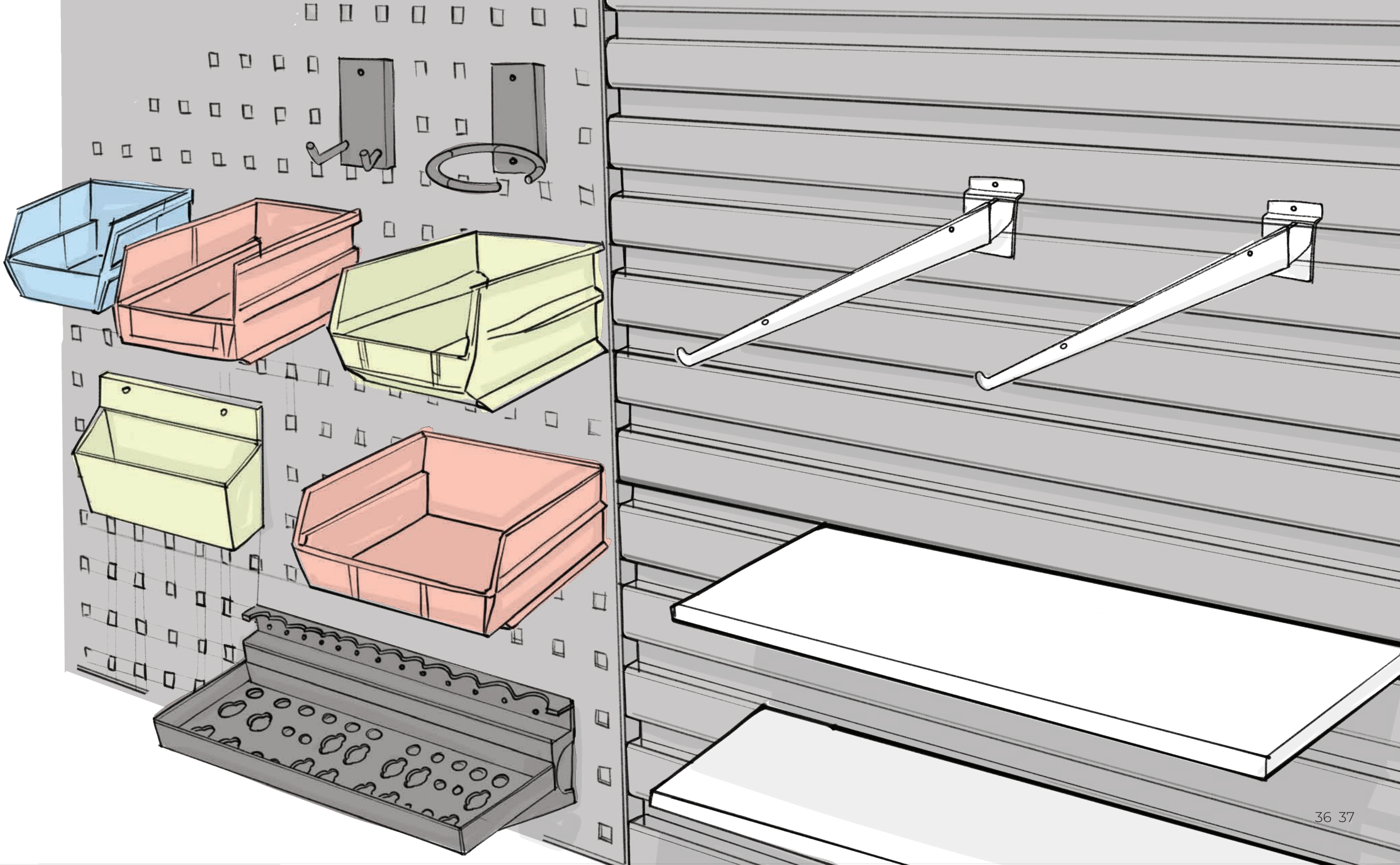

VersaSlat Storage Wall

This revolutionary storage solution offers unparalleled flexibility. Featuring horizontal grooves that accommodate a wide range of accessories including hooks, shelves, and specialized holders.

- Available in multiple colors and finishes
- Enables educators and students to customize storage configurations instantly
- Supports diverse learning tasks and teaching styles
- Adaptable design allows for quick reconfiguration
- Tailors storage solutions to specific classroom needs

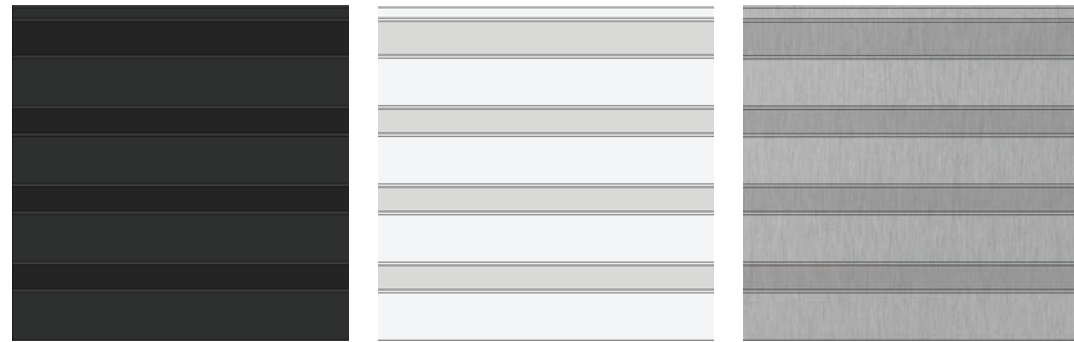

StoreWall

The StoreWall storage system revolutionizes organization in STEAM, maker, and learning spaces with its robust design. Its square-hole pegboard construction offers superior durability, ensuring that hooks and resources remain securely in place even in high-activity environments.

- Provides open and accessible storage for tools and resources
- Minimizes setup time for students and educators
- Encourages efficient material management
- Fosters a more organized and productive learning environment

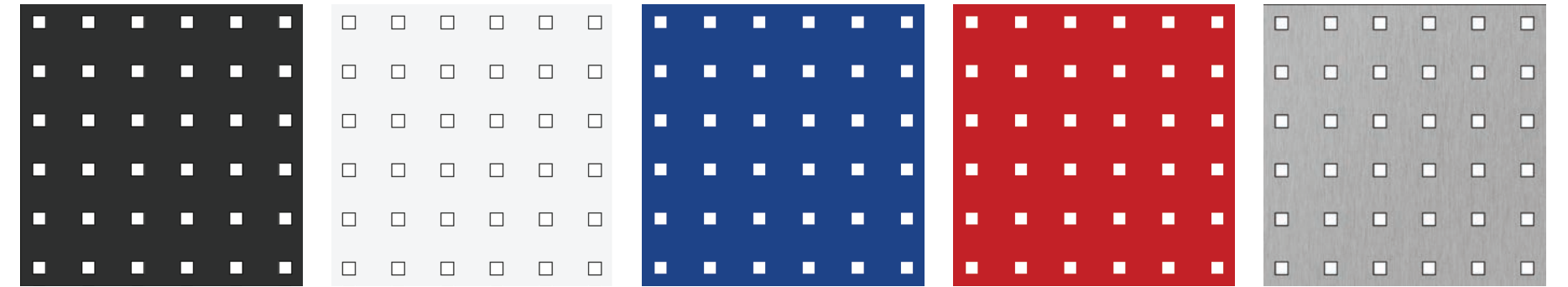



COMPANIONS

THE 5TH WALL

The 5th Wall Solution maximizes the use of vertical space in the classroom. Its dual functionality eliminates the need to choose between storage and interactive wall space, effectively doubling the utility of the wall area.

- Optimizes classroom space utilization by adding an additional usable vertical surface.
- Enhances organization and reduces clutter.
- Provides flexible, interactive learning surfaces.
- Improves accessibility to supplies and materials.
- Creates a more dynamic and adaptable classroom environment.

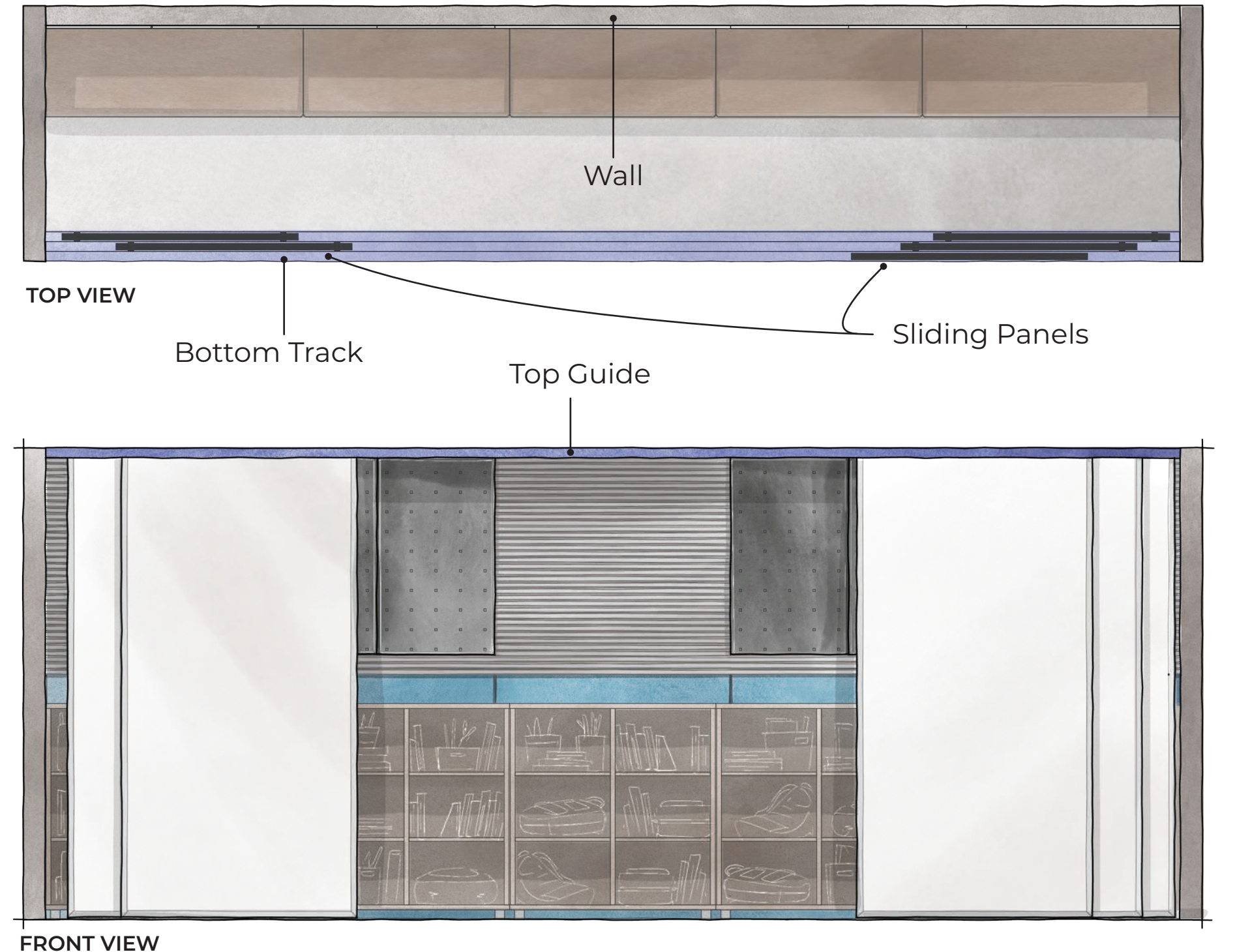

TOUCHDOWN ZONE+

The TouchdownZone+ is a flexible, space-saving solution that enhances student engagement, focus, and classroom versatility. Folds flat against the wall to maximize space while offering multipurpose functionality.

- Durable, institutional-grade materials available in various colors and patterns.
- Lightweight, easy to clean with bleach, and designed for quiet, calming student areas with teacher visibility.



HIDEAWAY STORE WALL

The Hideaway Store Wall is a smart and versatile storage solution designed to keep essential items accessible yet neatly concealed. Featuring a slat wall interior and customizable storage tubs, it provides an efficient way to organize frequently misplaced or discreetly stored items.

Combining functionality with sleek design, it serves as the ultimate organizational assistant for educators, seamlessly integrating into any learning environment.

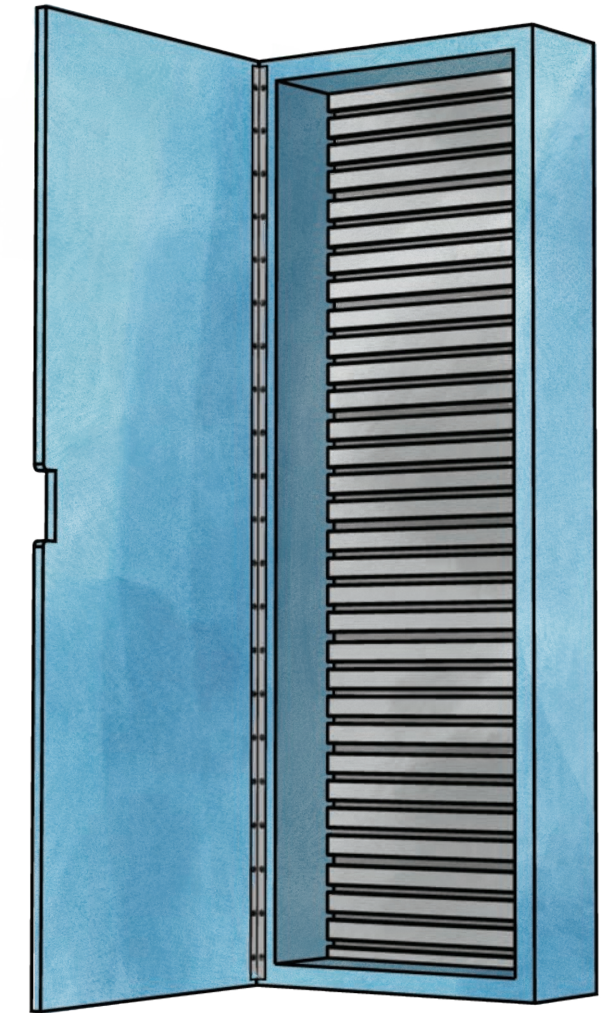
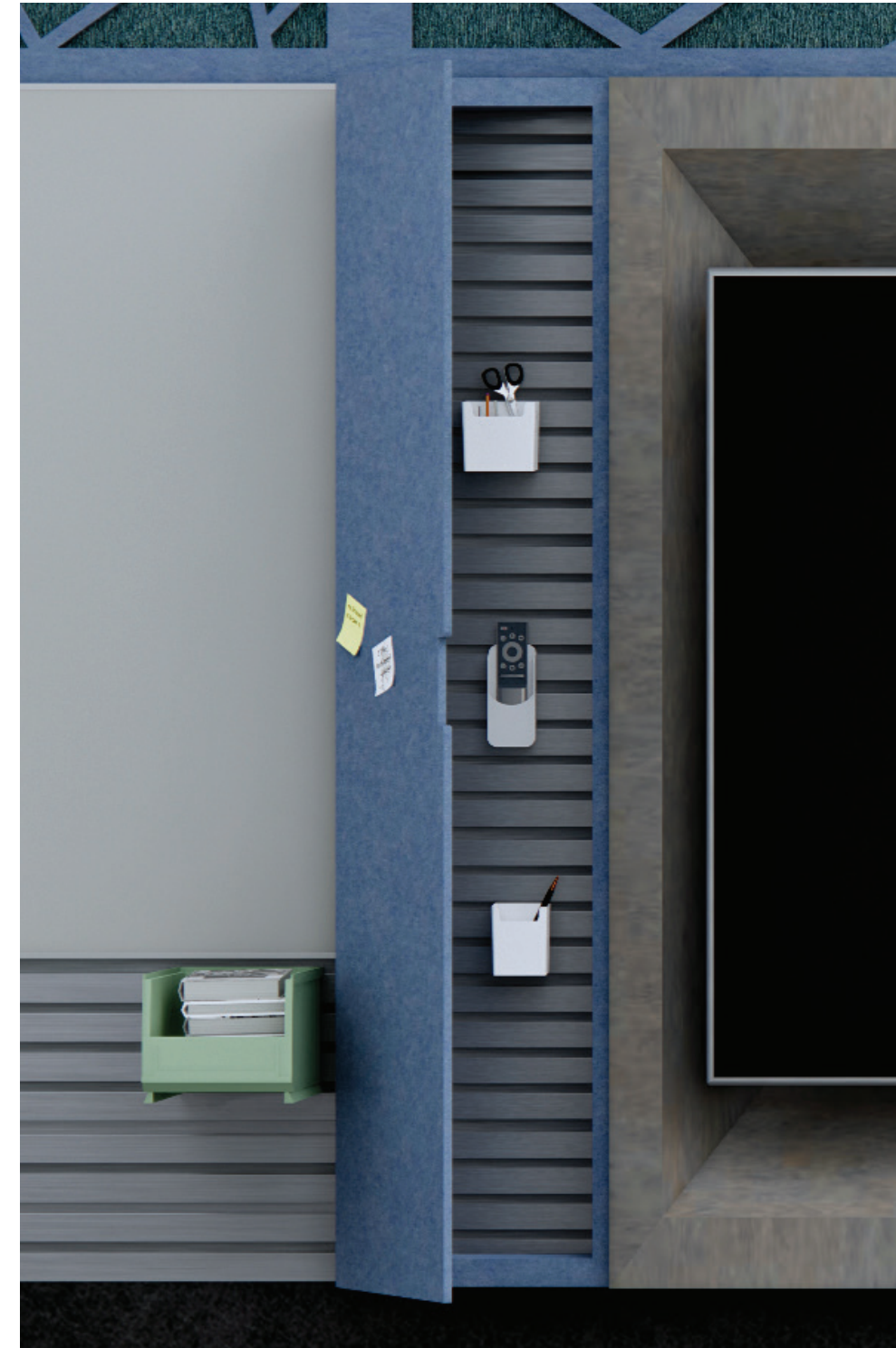



Calendar and various notes pinned to the wall.

	1	2	3	4	5
MON	Design & Technology	English	Maths	History	
TUE	Science	English	Art	PE (Outdoor)	Music
WED	Maths	English	History	Geography	Music
THU	Maths	English	History	Maths	Science
FRI	PE	English	English	Science	Geography

TO DO LIST

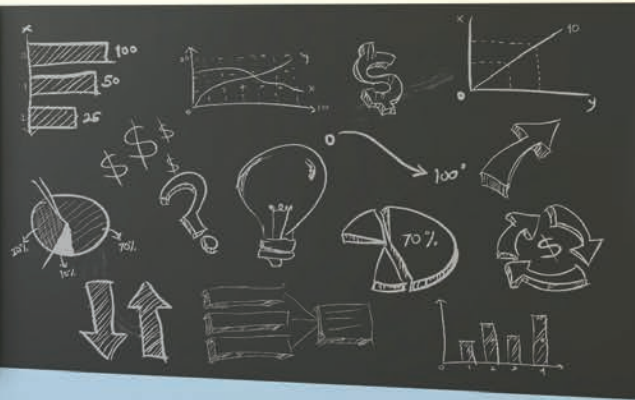

Blue bulletin board with several papers and photos pinned to it.

Qualities we admire in others

KNOWLEDGABLE
good listener thoughtful
talented
causing
warm
potent
HUMBLE
honest
generous with their time for us
slow to judge
conscious
INSPIRING
welcoming and aim to be around
resilient
selfless
strong

FAIR
open-minded
FUNNY
loving
FLEXIBLE

CHAPTER 4: GETTING ATTACHED

INSTALLING P360

When installing P360 to a wall surface it is important to know the type of wall composition to ensure a comprehensive installation.

Here is a breakdown how our P360 system attaches.

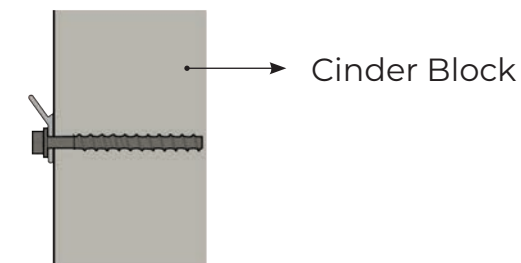
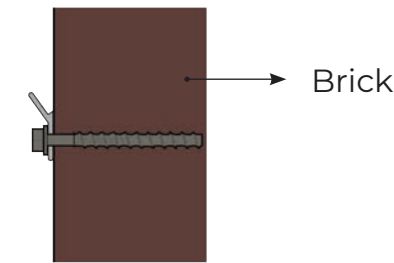
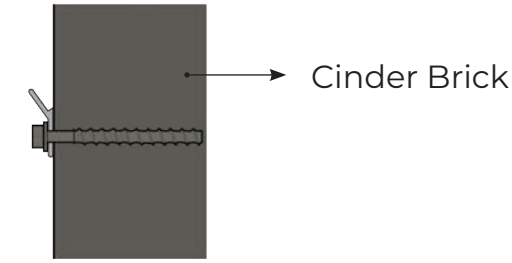
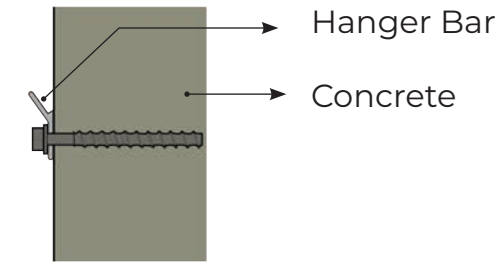

Mount to concrete masonry materials

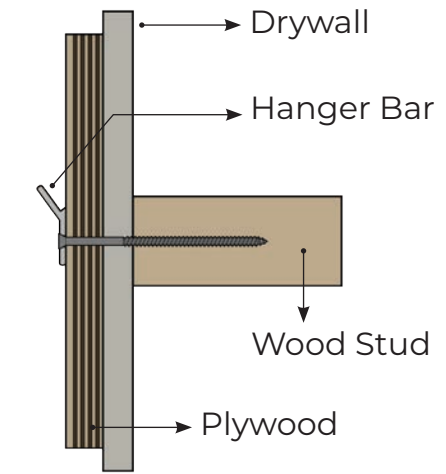

Mount to Plywood

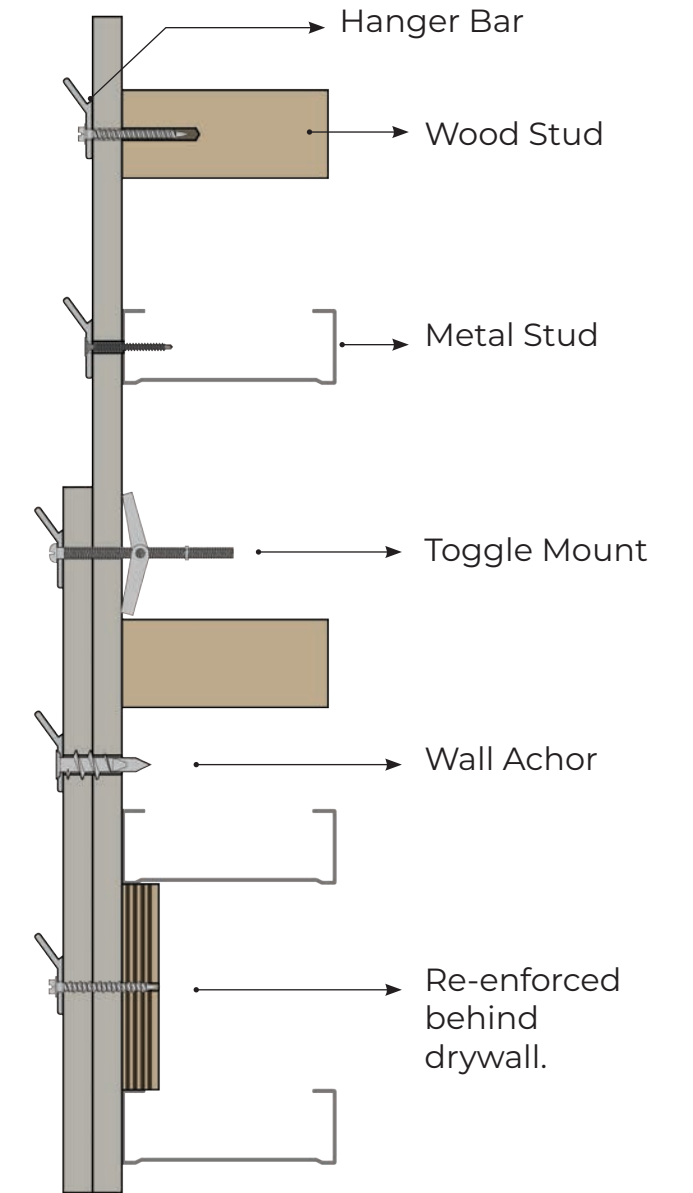

Mounting methods

* P360 is recommended to be installed by an authorised Platinum installation

TRACK STAR MOUNTING SYSTEM

The Track Star Mounting System can be easily retrofitted to any existing wall, seamlessly integrating into any learning space. This innovative system transforms environments by serving as the key functional element that activates the wall, unlocking new possibilities for organization, display, and interaction. With Track Star, every wall gains a new dimension, enhancing both functionality and versatility in any educational setting.

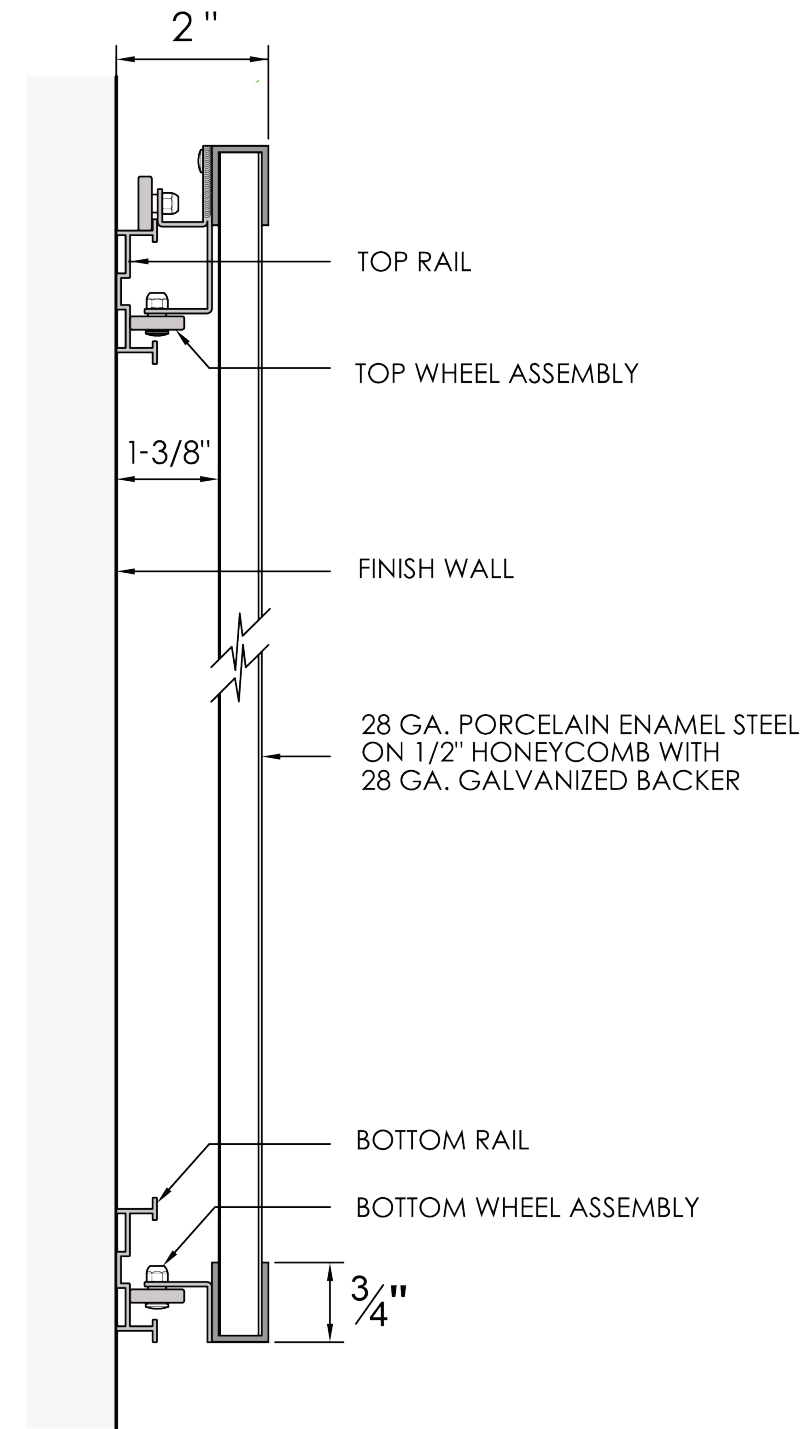

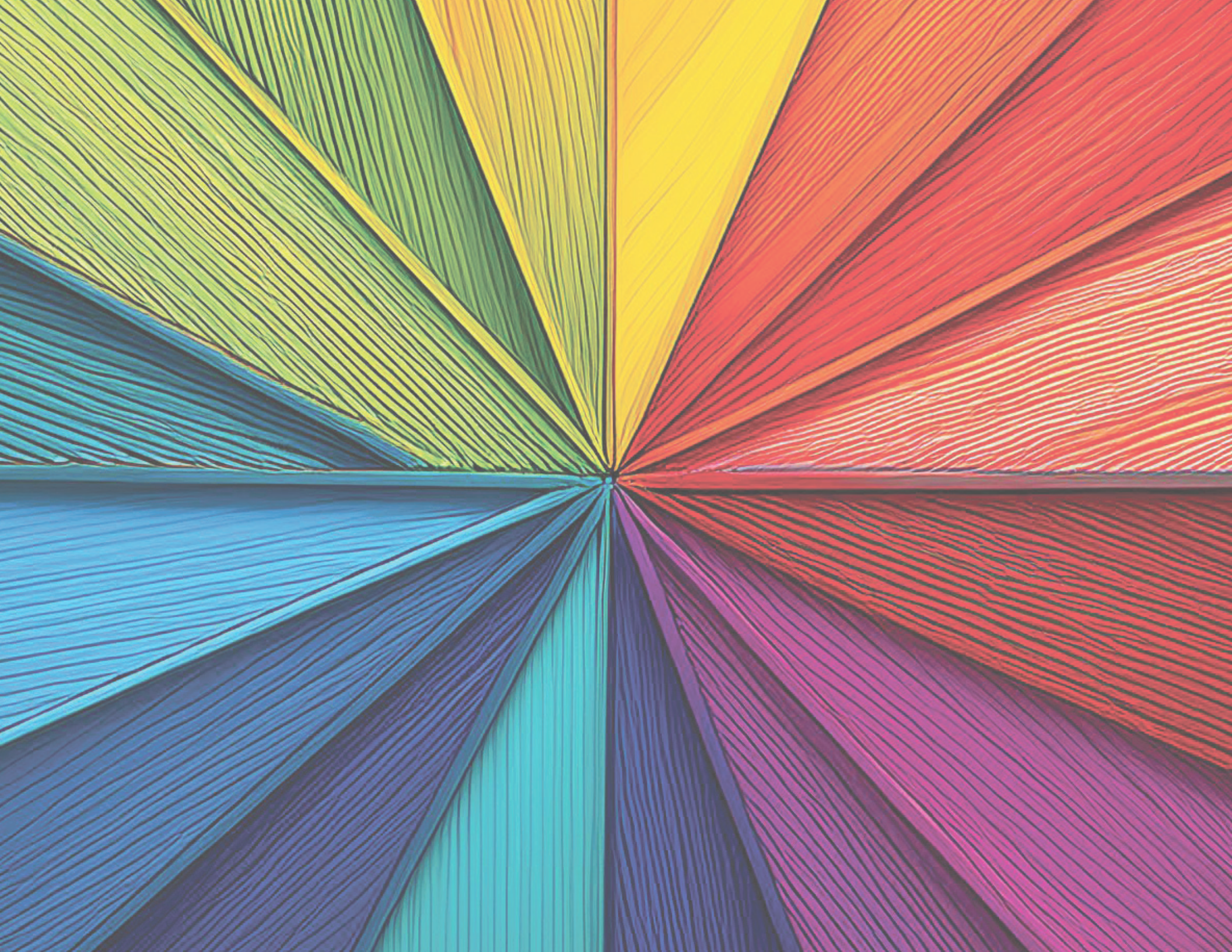

CHAPTER 5:
THE SCIENCE OF COLOR

OUR COLOR STORY

Vetted in research our choice of finishes and materials from the colors to the textures are selected based on their value to the learner and learning.

Considering sensory, visual and cognitive processing research our color palette has been designed to facilitate and activate the learning process and create a sense of well being and inclusivity.



OUR FAVORITE PALETTES

Meadow Vibes

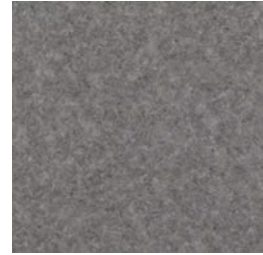

SomaSound:
Pewter



TouchTone:
Calgary Lime

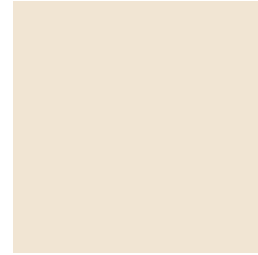

Writanium:
Beige/Moonlight



SomaSound:
Grass

Ocean Vibes



SomaSound:
Cobalt



SomaSound:
Sky

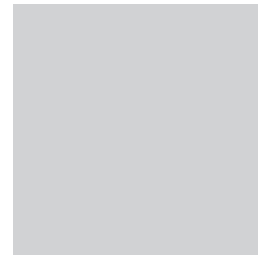

Writanium:
Light Grey



TouchTone:
Penang Ash

ADD FUNCTIONAL STORAGE

VersaSlat

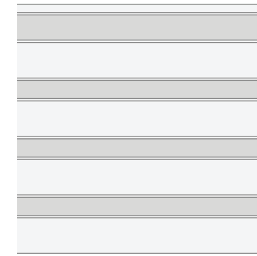

StoreWall

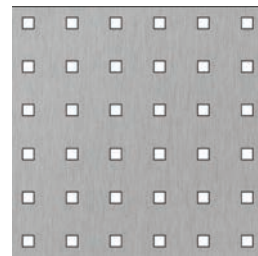

OUR FAVORITE PALETTES

Morning Glow



SomaSound:
Saffron



TouchTone:
Sunshine



Writanium:
Blush



SomaSound:
Iron Bark

Quiet Echo



SomaSound:
Chambray



SomaSound:
Sky



Writanium:
Light Grey

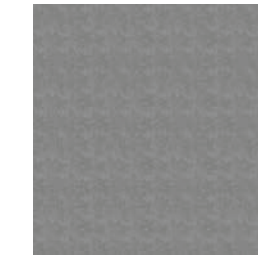

TouchTone:
Calgary Cement

ADD FUNCTIONAL STORAGE

VersaSlat

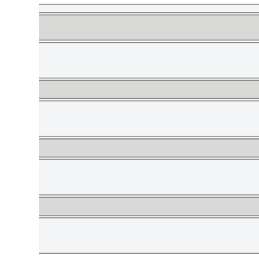

StoreWall

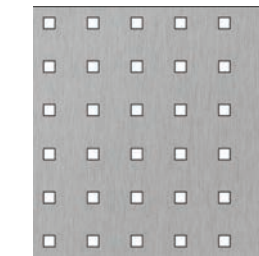

ACOUSTICS

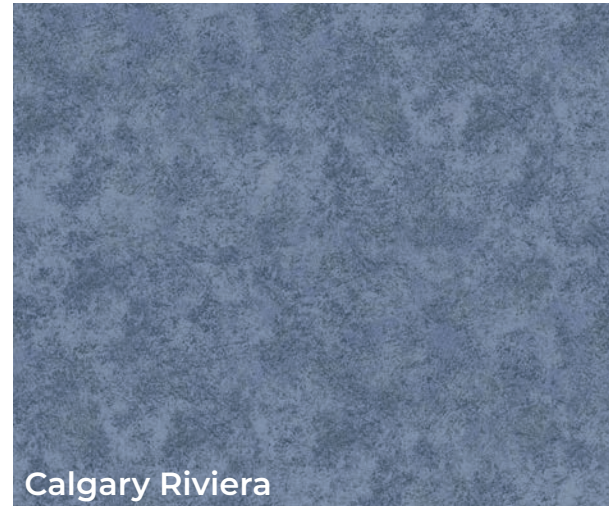

Calgary Riviera

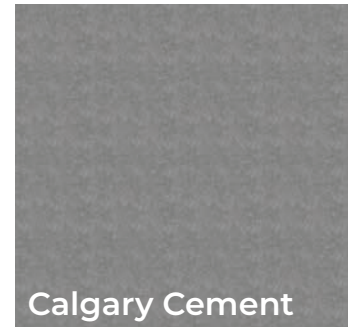

Calgary Cement



Penang Grey



Penang Purple

TOUCHTONE

Notable for its tackability, sensory feel, and variety in patterns/colors, enhances room acoustics when used with flooring.



Penang Orchid



Metro Gold



Metro Cocoa



Metro Anthracite



Metro Lilac



Calgary Fire



Calgary Lime

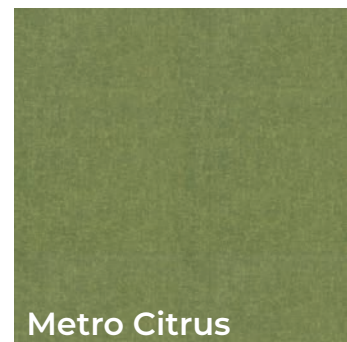

Metro Citrus



Metro Evergreen



Grass

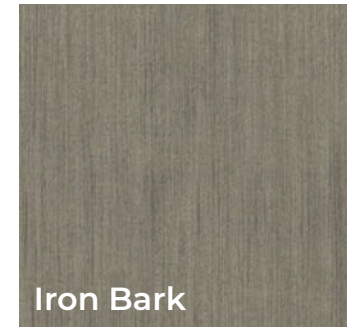

Iron Bark



Mandarin



Spotted Gum



Sunshine



Sky



Slate



Cobalt



Olive

SOMASOUND

Outstanding acoustics and environmentally friendly components.

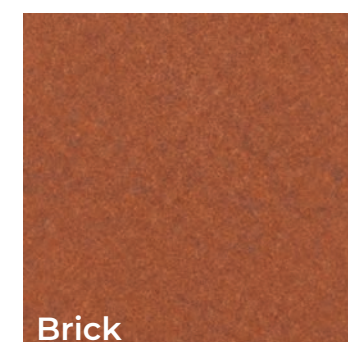

Brick

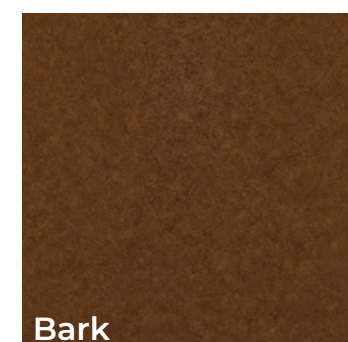

Bark



Saffron

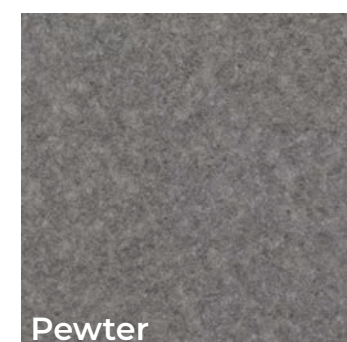

Pewter

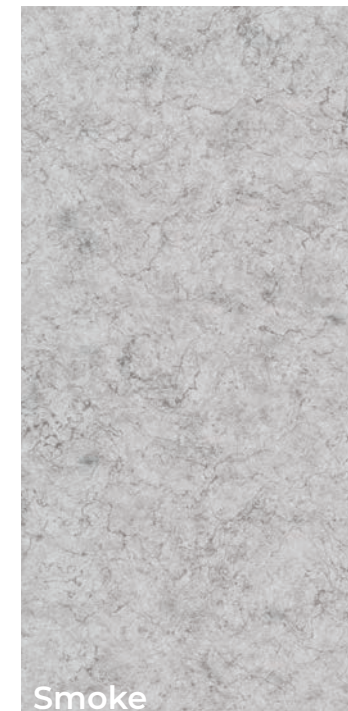

Smoke

WRITANIUM™

Guaranteed for the life of the building, it's durable, prevents ghosting, and boasts a proven 70-year track record.

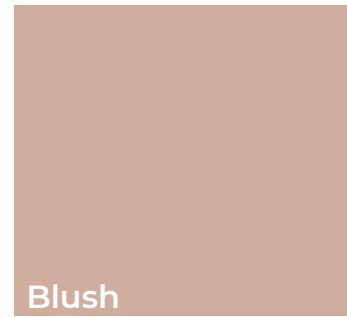
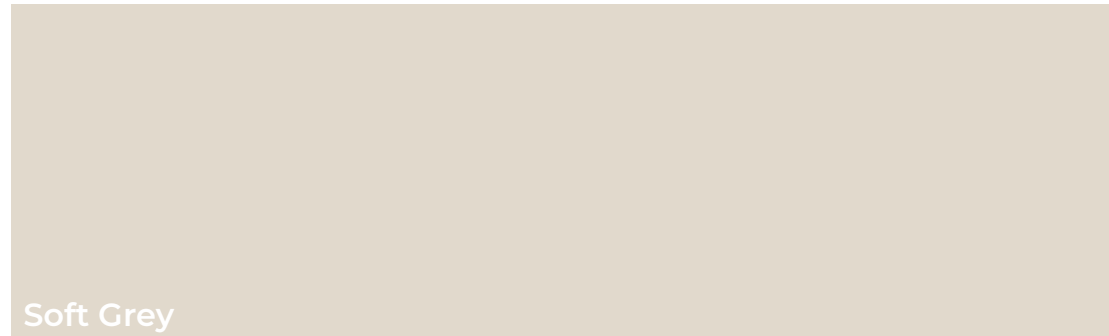
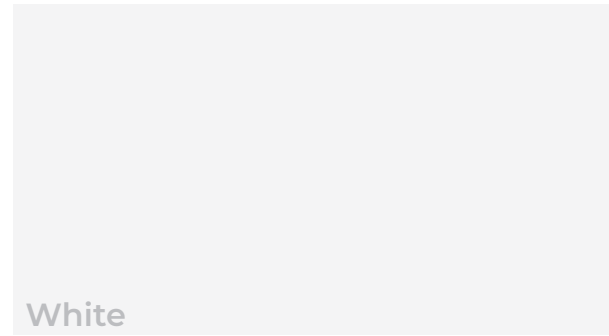
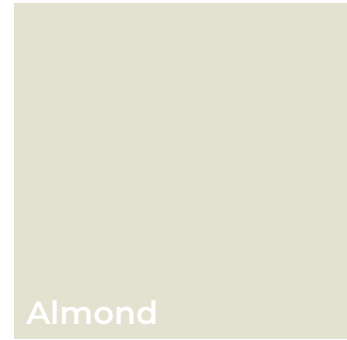
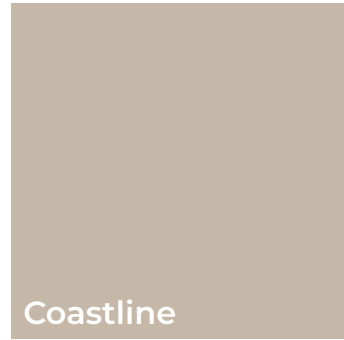

VERSASLAT

Aluminum is selected for its durability and toughness, ideal for classrooms.

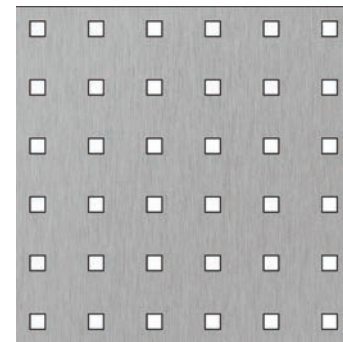
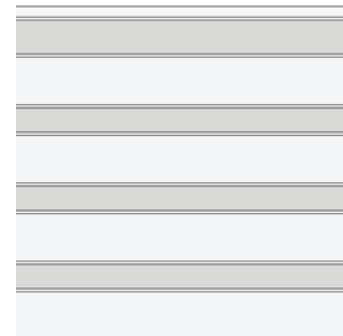

STOREWALL

Chosen for its magnet-holding capabilities and secure accessory mounting.

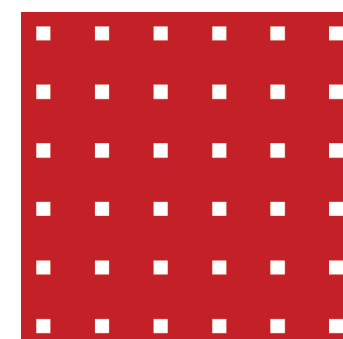
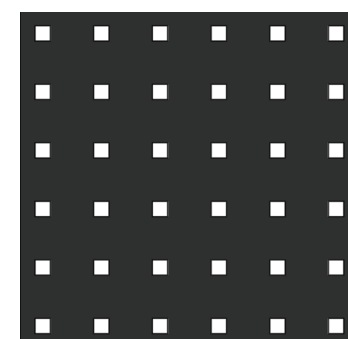
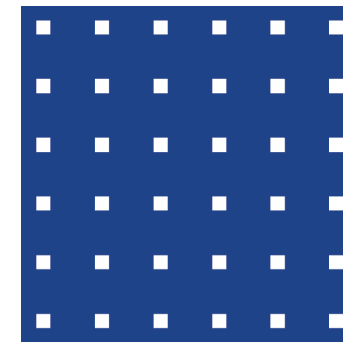

OUR STORY...



YOUR STORY...

CHAPTER 6:
YOUR STORY, OUR STORY

Our customers are more than clients—they're our collaborative partners in reimagining educational spaces.

Driven by these success stories we continue to innovate and relentlessly pursue solutions that activate the vertical space.



"I was very pleased with the custom oversized cases and sliding doors. Platinum customized them to fit what we needed. They are very noticeable when you walk in the building. People stop to admire the art inside."

– Michael Chewning, Dorman High School

"I really like the teaching space. We have new whiteboards all around. I really like that fact. It's just more suited for a classroom learning experience."

– Ivan Wong, Harvey Mudd College



"Everyone enjoys using the whiteboards; they really maximize the space."

– Brian Faber, Pomona College



SOLUTIONS FOR ALL FOUR WALLS